

# Solar Battery Powered PTZ Alert Camera

## User Manual

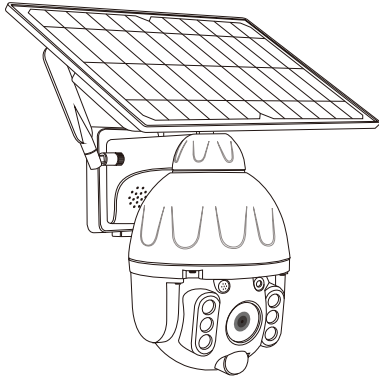

V1.3

### 1. PRODUCTS & PACKING LIST

#### 1.1 Product Diagram:

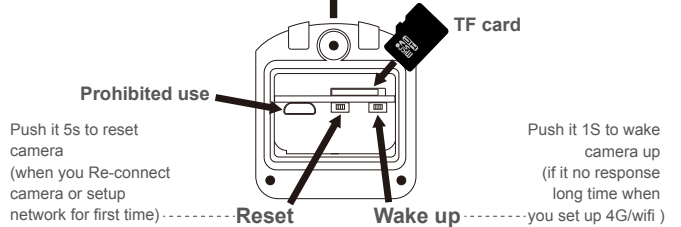
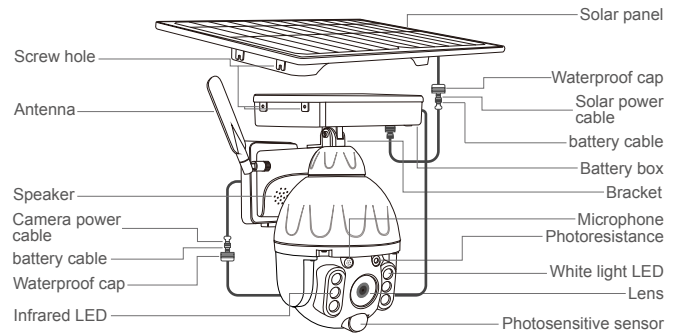

#### 1.2 Battery partner:

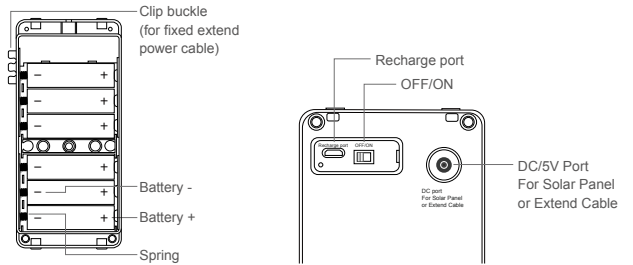

- 1 -

#### 1.3 Packing list:

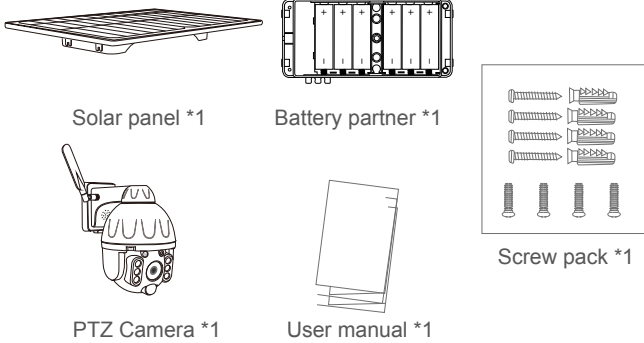

### 2. INSTALLATION METHOD

- 2.1 Intergrated installation
- 2.2 Split Installation
- 2.3 Extend Installation

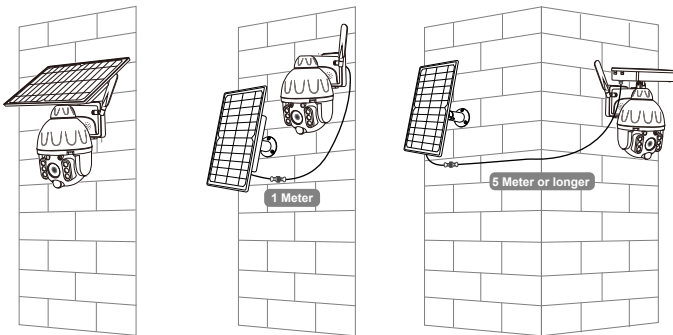

Accessories needed (not standard configuration)

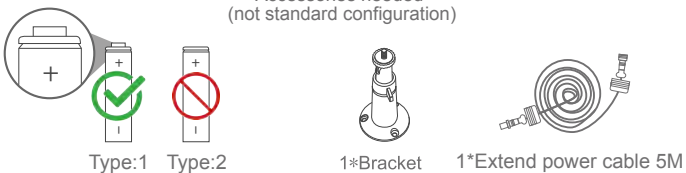

### ATTENTION :

Fully charge the battery when using the camera for the first time.

### 3 APP REGISTRATION

3.1. Search and download "Tuya" in major applicatio markets or scan the QR code below to download the APP.



iOS / Android

### 4. ACCOUNT REGISTRATION AND LOGIN

4.1. Once you download the APP to your smart phone, you may enter the first page which you can Login with existing account or register.

\* If you are the new user of Smart Life and don't have an account, please choose register first and follow the below screenshots to complete the registration.

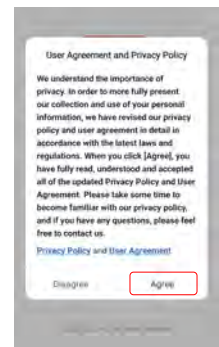
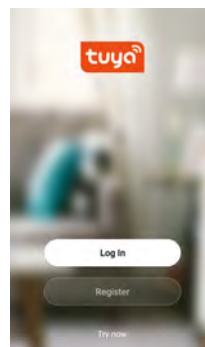

4.2. If you have the existing account, there are two ways to login, one is with SMS verification Code, the other one is with password. In case you forget the password, you may choose login SMS verification Code or you can choose forgot password to reset it by Entering Verification Code which sent to you mobile via message.



## 5. CONNECTING THE CAMERA TO YOUR MOBILE DEVICE

5.1. Connect the mobile device to your 2.4GHz Wi-Fi, then log in to Tuya. click 'Add Device' on the Home of the App, select "Security & Video Surveillance", "Smart Camera", click "Next".

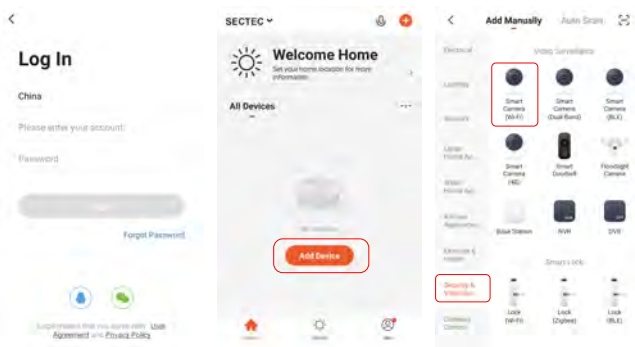

5.2. Make sure the indicator is flashing quickly or a prompt tone is heard click "Next". Enter Wi-Fi account and password, click "Next". Hold the mobile phone screen in the front of the camera, the distance between the two should be 15 to 20 cm, Try not to shake the mobile phone during the scanning.

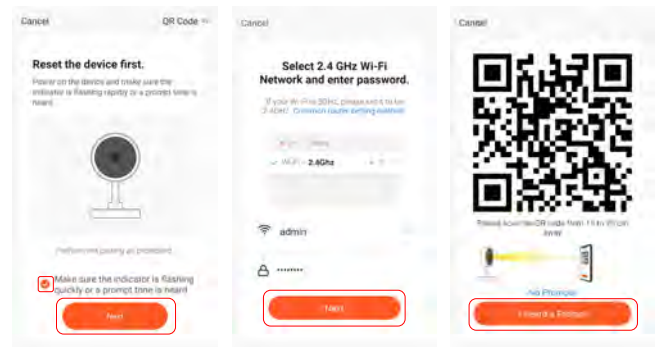

5.3. When you hear 'Connect Router', click "I Heard a Prompt", and wait for connecting, Device added successfully, you can choose the device name and room scene.

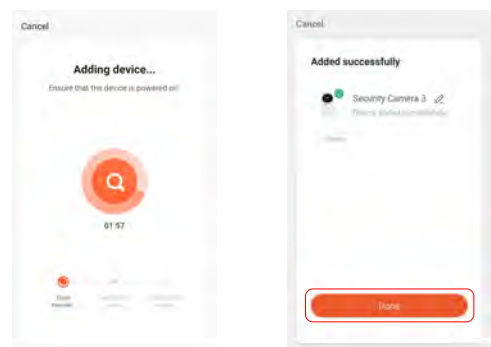

## 6. FUNCTIONS INTRODUCTION

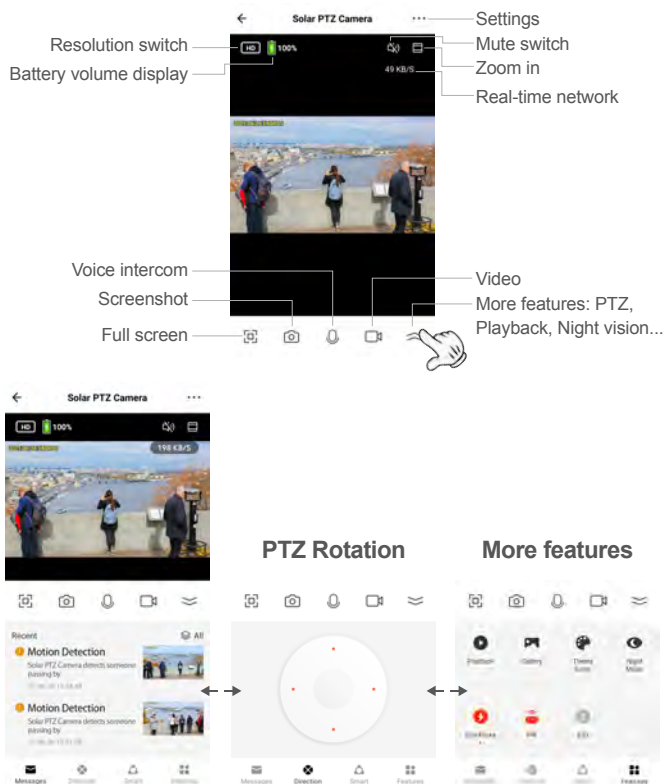

### Notes about PIR detection

- \* User can change the PIR detection sensitivity in device settings. we recommend to set sensitivity at "Disabled" or "Low" to reduce false alert and save the battery power in noisy environments.
- \* Shut down: shut down PIR detection.
- \* Low: delay 7 seconds PIR detects a moving.
- \* Medium: delay 5 seconds PIR detects a moving.
- \* High: delay 1 second PIR detects a moving.

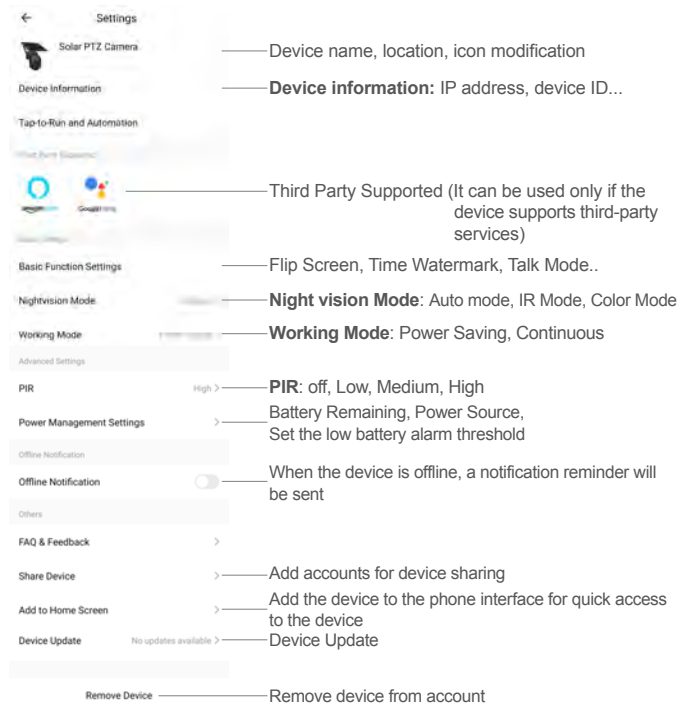

### FAQ:

After the configuration is done, our device will be showed on Smart Life APP which enable you to surf the smart living easily. If you have any questions about App using, you may go to category "me" to find the "Help Center" and check if you have the same issues. If not, you can report the issue and then your problems will be handled and answers will be given soon if you provide as much information as you can.

### SAFE BATTERY HANDLING AND USAGE

During the installation of the battery, the positive and negative poles of the battery should not be reversed to avoid fire.